

FRONT

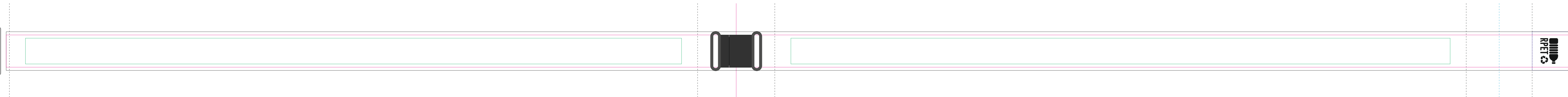

BACK

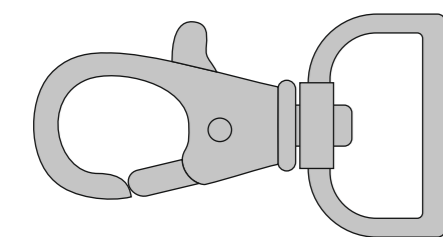
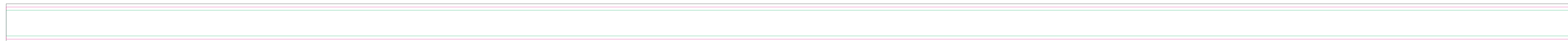

FRONT

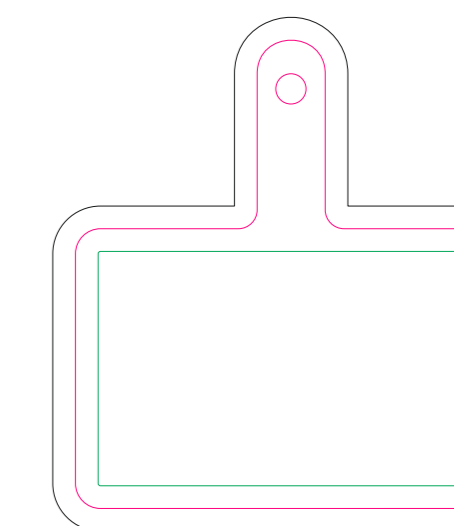

BACK

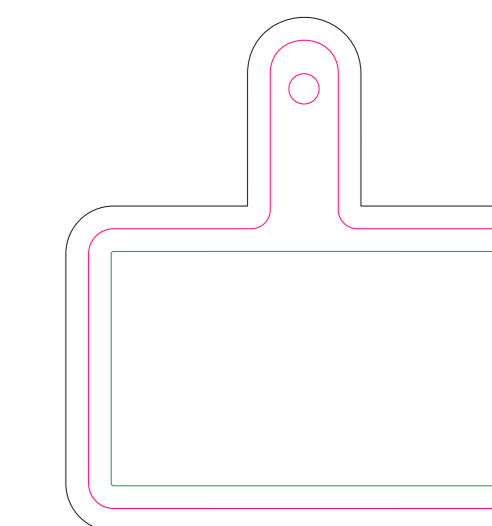







Due to the characteristics of the printing process, the back side of the ribbon cannot be positioned relative to the front side, so the placement of the graphics on the back may differ from the position of the graphics on the front. By approving this print proof, you acknowledge that no claims related to the placement of the backside graphics will be accepted.

resolution: min. 300 DPI
colours: CMYK
formats: TIFF, PDF, EPS, AI, CDR

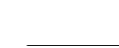

The green line indicates the area all non-background object-texts, logos, etc.
The pink outline the maximum size of graphic visible on the product.
The black line indicates the size of the required graphics including bleed.
The dash line indicates the point of the seam.
The blue line the size of the required graphics including bleed and fold.

-  Margin
-  Edge of product
-  Bleed limit 2-2 mm (background must fill it)
-  Seam
-  Fold line
-  +24 mm seam by the small strip with background colour

FRONT

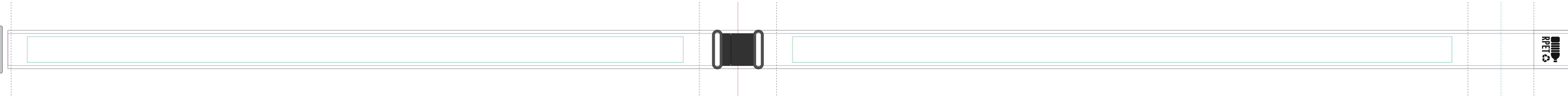
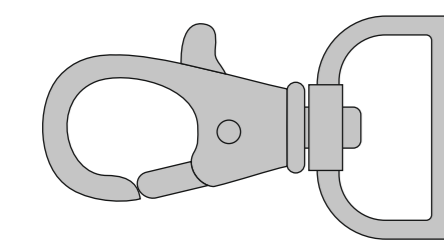

BACK

FRONT

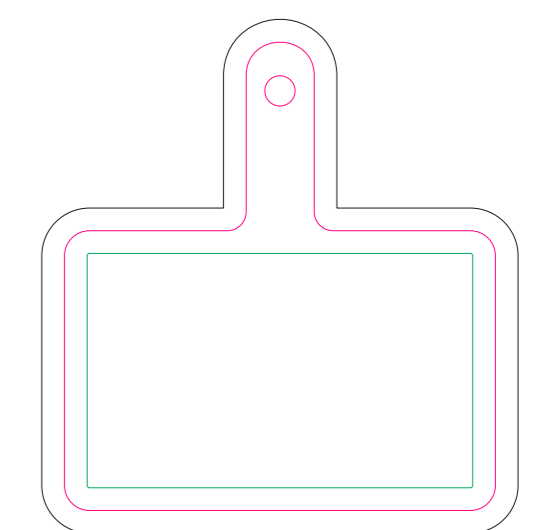

BACK

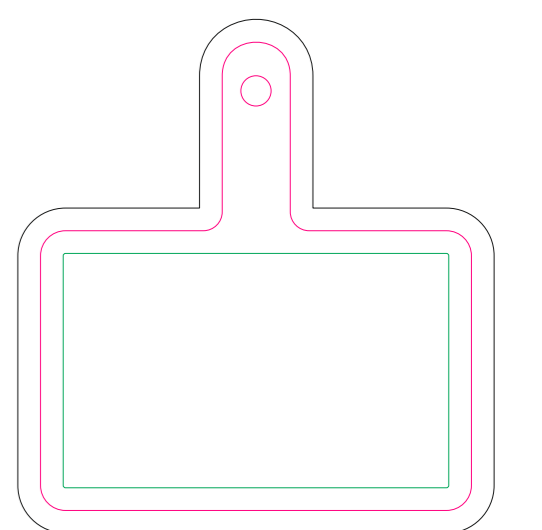

Due to the characteristics of the printing process, the back side of the ribbon cannot be positioned relative to the front side, so the placement of the graphics on the back may differ from the position of the graphics on the front. By approving this print proof, you acknowledge that no claims related to the placement of the backside graphics will be accepted.

resolution: min. 300 DPI
colours: CMYK
formats: TIFF, PDF, EPS, AI, CDR



The green line indicates the area all non-background object-texts, logos, etc.
The pink outline the maximum size of graphic visible on the product.
The black line indicates the size of the required graphics including bleed.
The dash line indicates the point of the seam.
The blue line the size of the required graphics including bleed and fold.

- Margin
- Edge of product
- Bleed limit 2-2 mm (background must fill it)
- Seam
- Fold line
- +24 mm seam by the small strip with background colour